

SHAFT - 16900

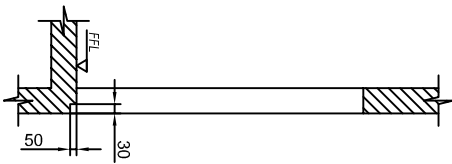
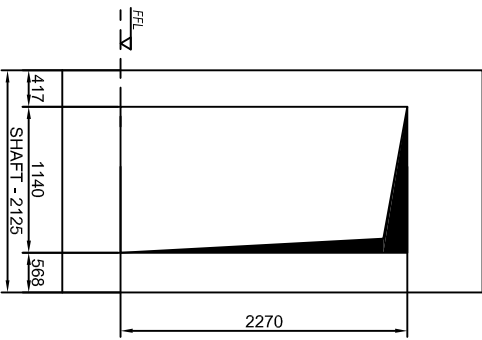
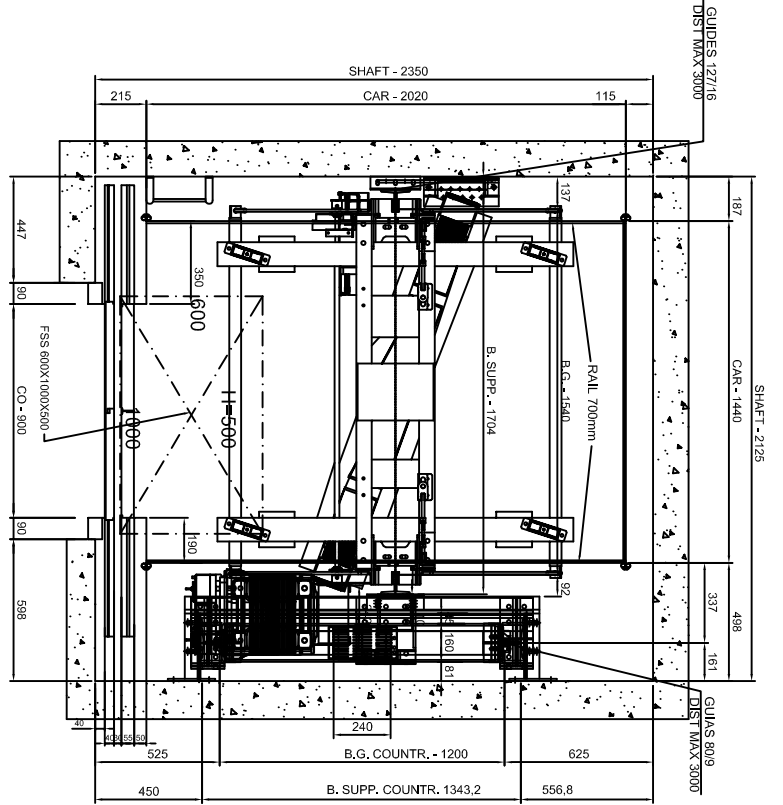
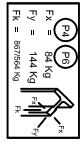
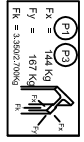
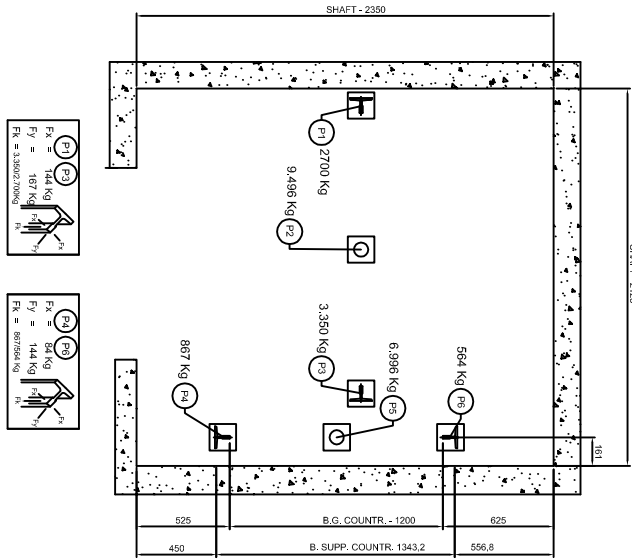
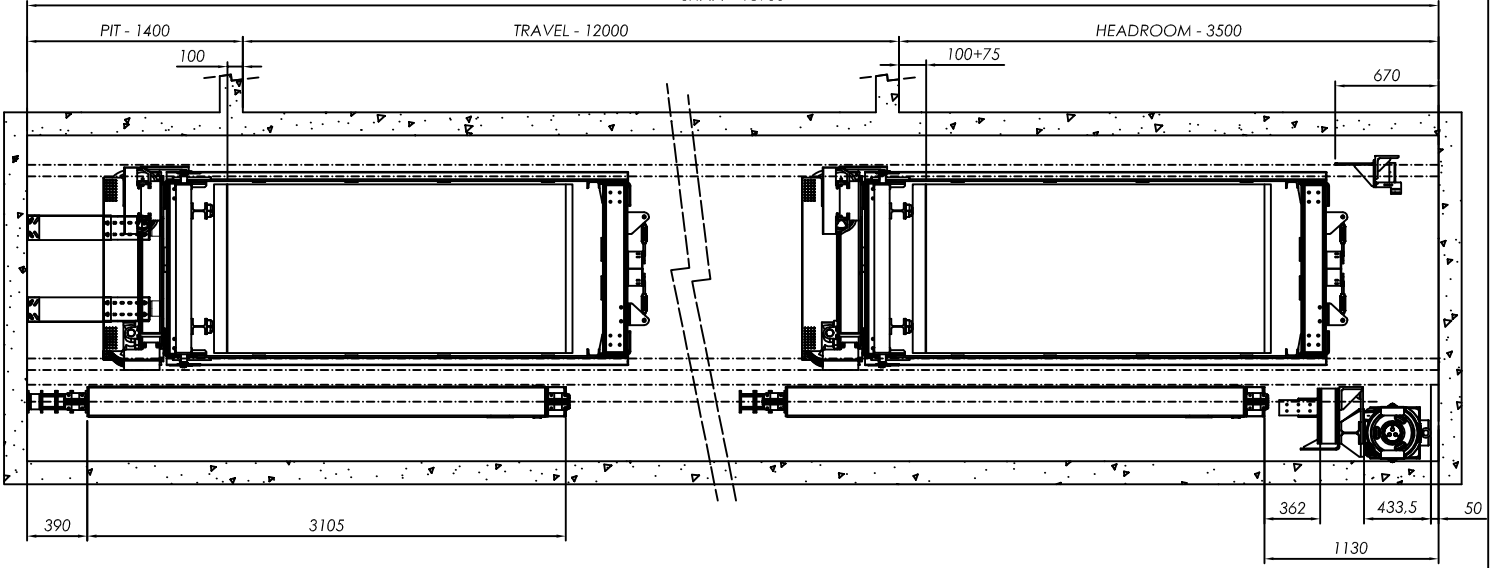

Notes

1.

DRAFT DRAWING

Scale	1	Page	1 of 1
Drawn	Date	Chkd.	Rev.
Title			
EOLIFT			
Drawing No.			
A3			
Reference			
Client			
Comments			